



# EXFAN

Novel recuperation system to maximize EXergy  
From ANergy for fuel cell powered geared  
electric aircraft propulsion system

## Opportunities to move from heat rejection to heat utilization in hydrogen electric aircraft - exFan

Vienna Aviation Days 2024

Univ. Prof. Dr.-Ing. Martin Berens (BMK Endowed Professorship for Innovative Aviation Technologies)

Dipl.-Ing. Matthias Ronovsky-Bodisch (Aircraft Systems Research Group)



**Funded by  
the European Union**

Funded by the European Union. Views and opinions expressed are however those of the author(s) only and not necessarily reflect those of the European Union or CINEA. Neither the European Union nor CINEA can be held responsible for them.

# Basic Concepts



- Heat exchanger air duct and propulsor are combined
- The fan compression increases the efficiency of the Brayton cycle
- By heating the air flow, the volumetric flowrate increases and so does the jet velocity and the net thrust

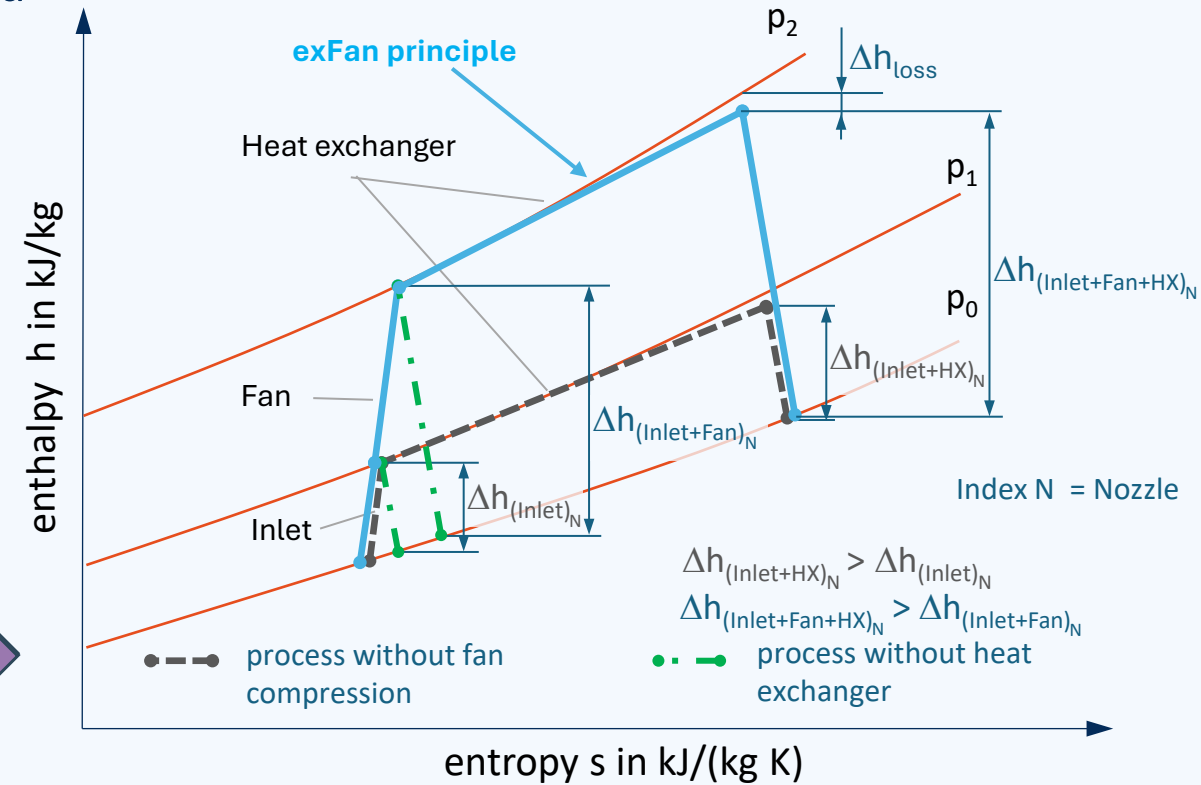
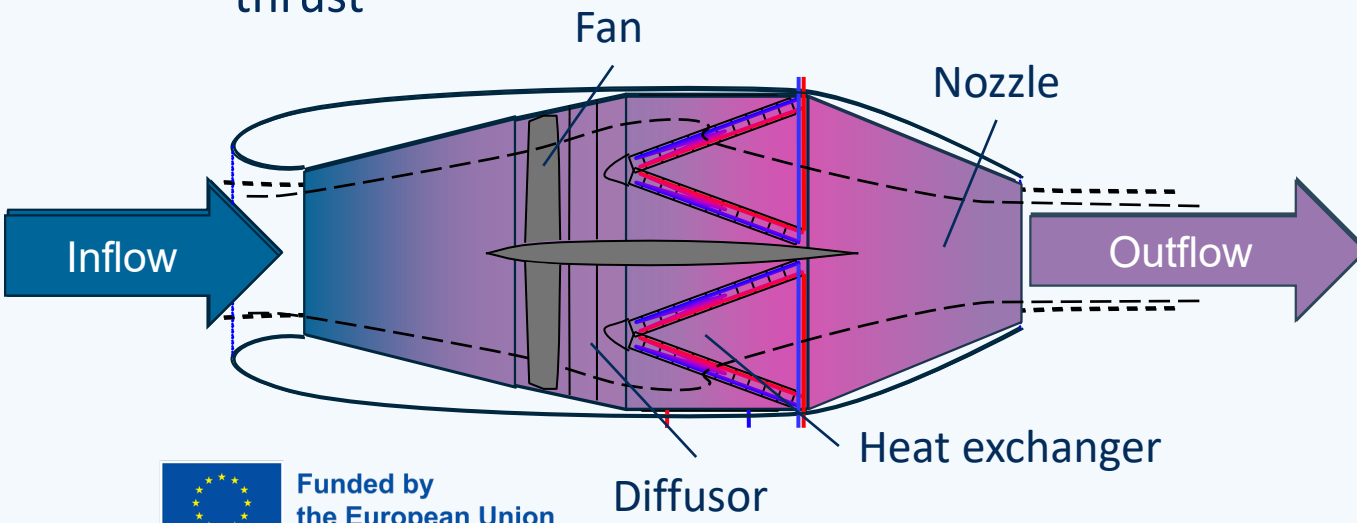

# Basic Concepts

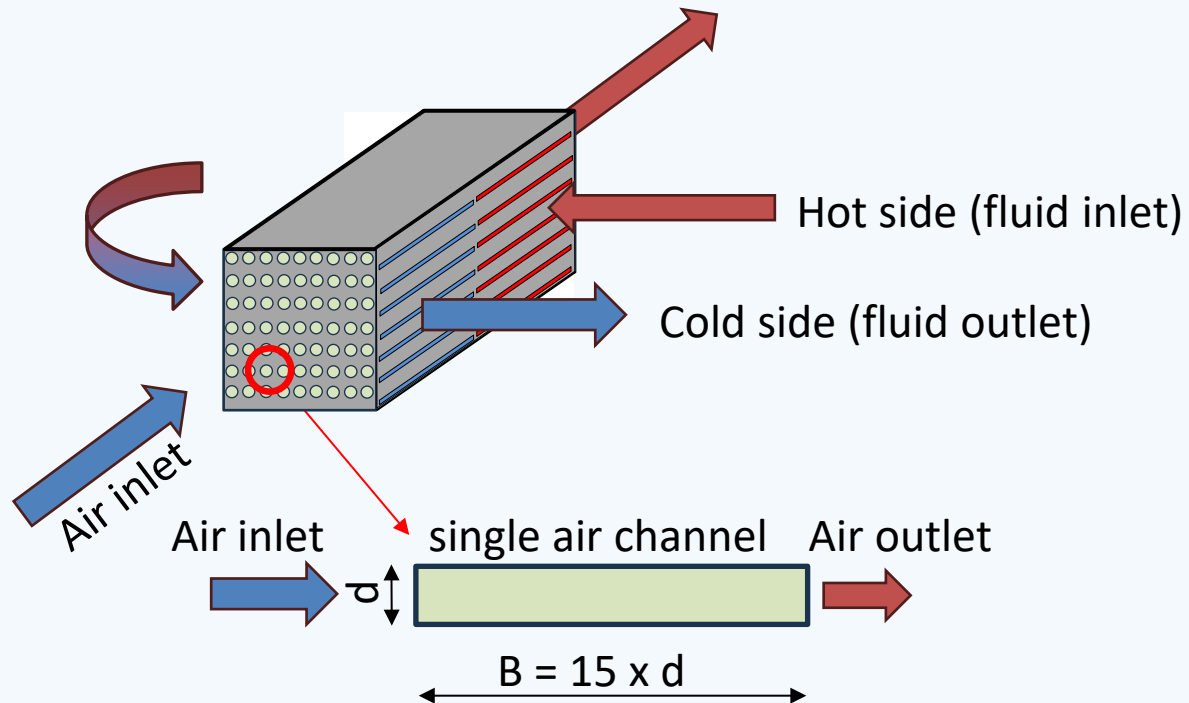

Comparison of Pressure loss vs Nusselt number plotted versus flow velocity in a pipe

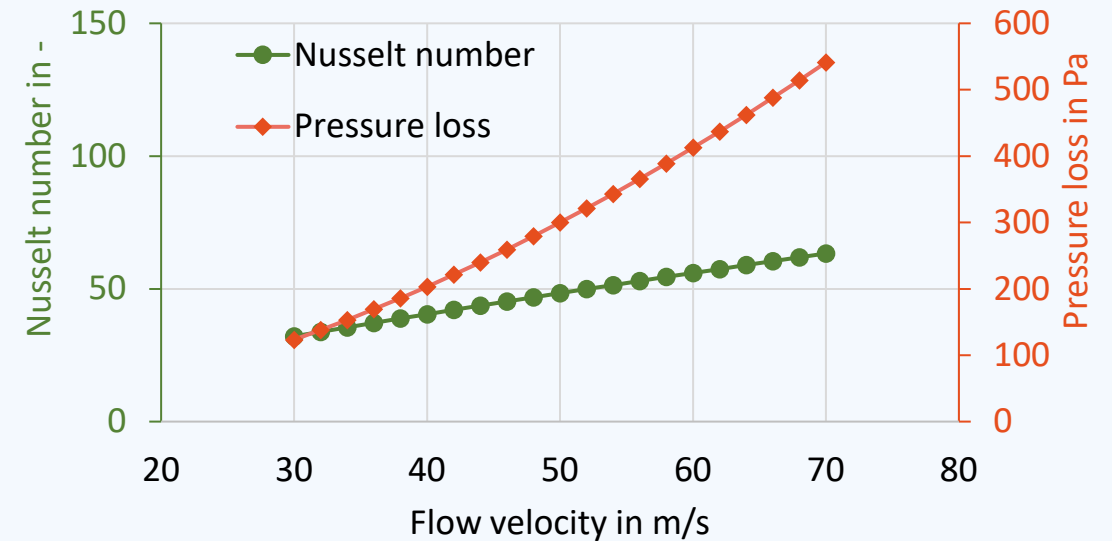

- Pressure losses outgrow the advantage of the increased Nusselt numbers with increasing flow velocity.
- It is advantageous to decrease the flow velocity and increase the HX air side surface area instead.

Nusselt number:  
Indicates how much heat is transferred to a fluid via a heat transfer surface.

# Basic Concepts



- Heat exchanger inclined arrangement following F1 example
- Flow cross section area is increased in order to reduce local flow velocities while large frontal areas are avoided.

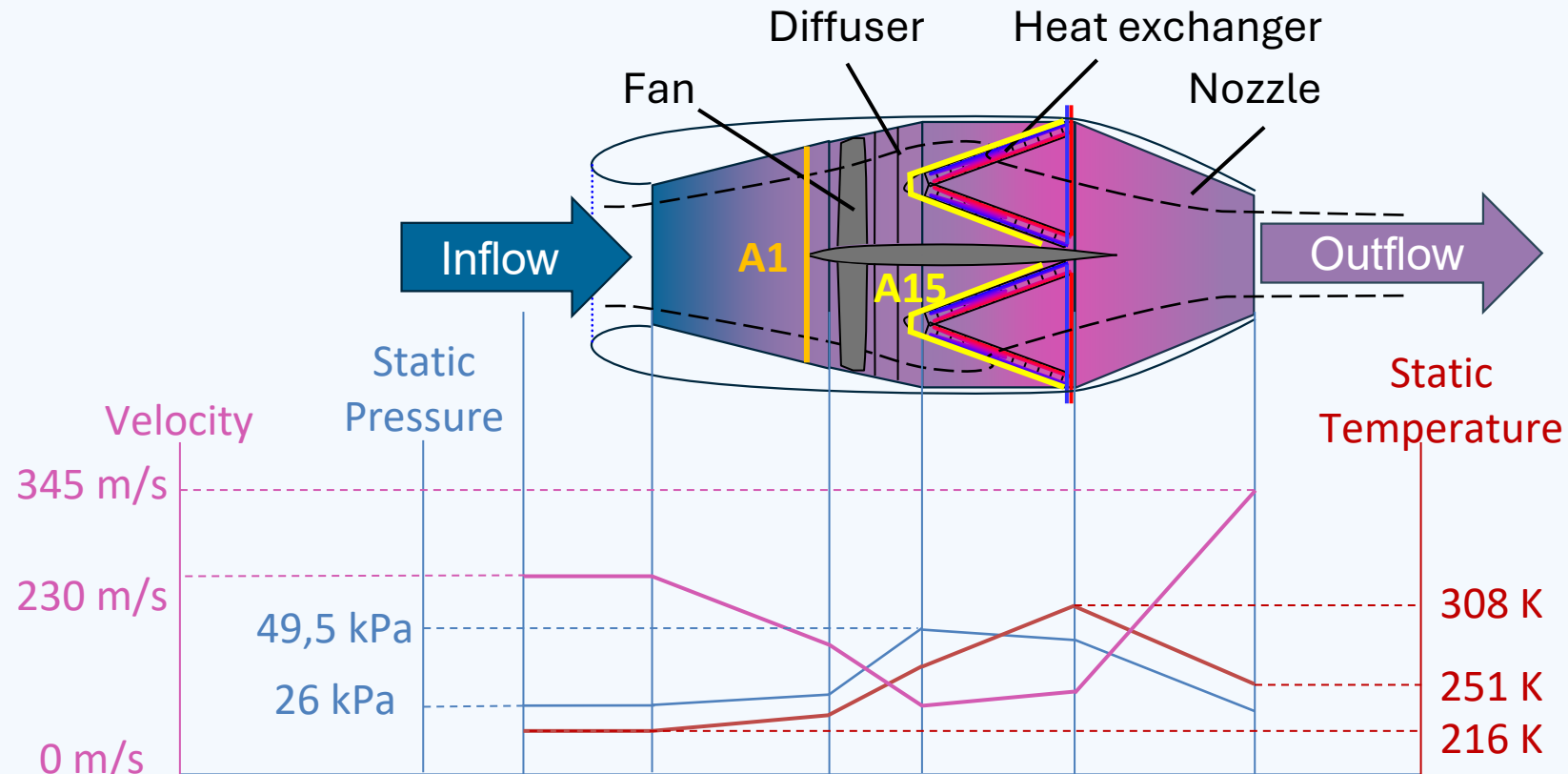

Data curves show development of average annular duct properties.

# Basic Concepts



- Model of an installed HX with no losses, low  $M_{15}$  compared with  $M_0$  and simplifications:

$$\eta_H = \frac{\text{Kinetic power recovered}}{\text{Total heat added}} = 1 - \left( \frac{P_{S,15}}{P_{S,0}} \right)^{\frac{1-\gamma}{\gamma}}$$

- Effectiveness of rejected heat conversion into kinetic jet power depends on pressure ratio  $\left( \frac{P_{S,15}}{P_{S,0}} \right)$ !
- Recuperated kinetic jet power depends on heat rate  $\dot{Q}_{PEMFC}$ , not on temperature.

$$\eta_T = \frac{\text{Added useful thrust power}}{\text{Total heat added}} = \eta_H \cdot \eta_j$$

$$\eta_j = \frac{\text{Propulsive power}}{\text{Kinetic jet power}}$$

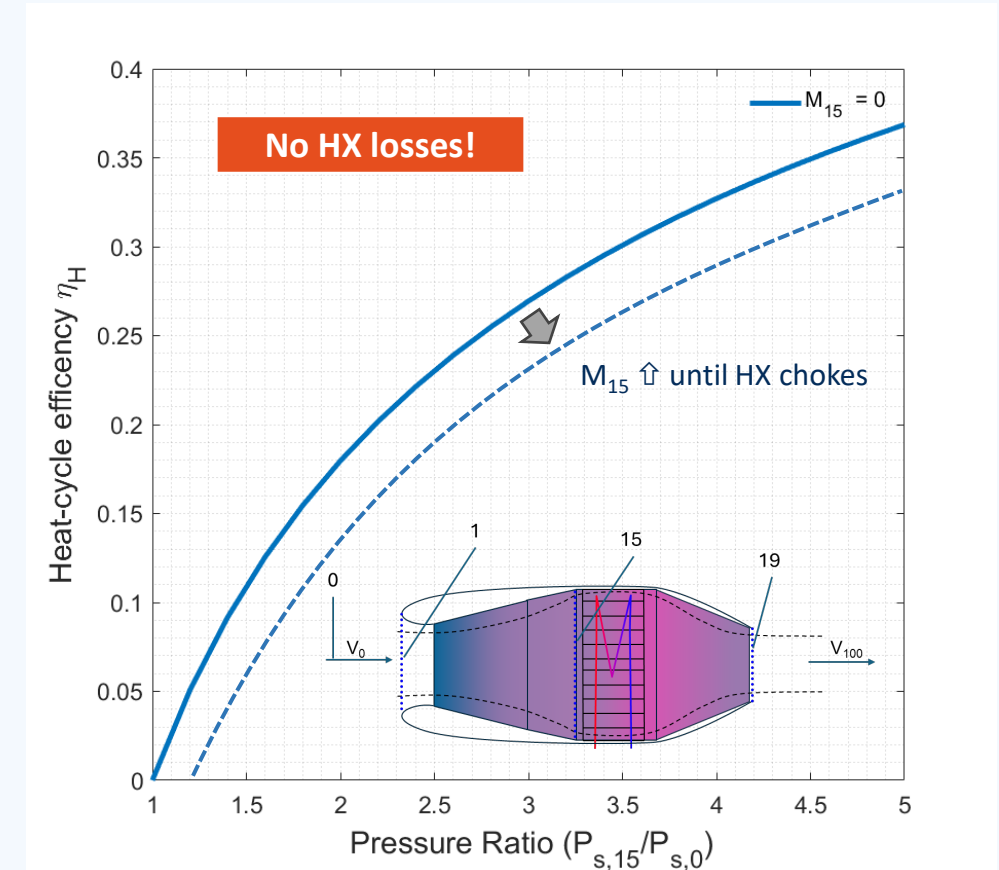

# Parameter Study - Assumptions



## General settings

- Focus on thermodynamics of heat propulsor!
- 0D-Modell for the heat propulsor except HX
- Not considered yet:
  - Fuel cell system ancillaries power variation with altitude, flight Mach, etc.
  - Nacelle external drag
  - System masses
- Engine of a twin engine SMR-a/c (A320 size)
- Sizing mode study: Component sizes are adapted to operating conditions  $\Rightarrow$  "Rubberized"
- Fixed fan inlet Mach number
  - $\Rightarrow$  Variable area nozzle / Fixed pitch fan rotor
- All fuel power that is not converted into mechanical shaft power is rejected as heat by HX

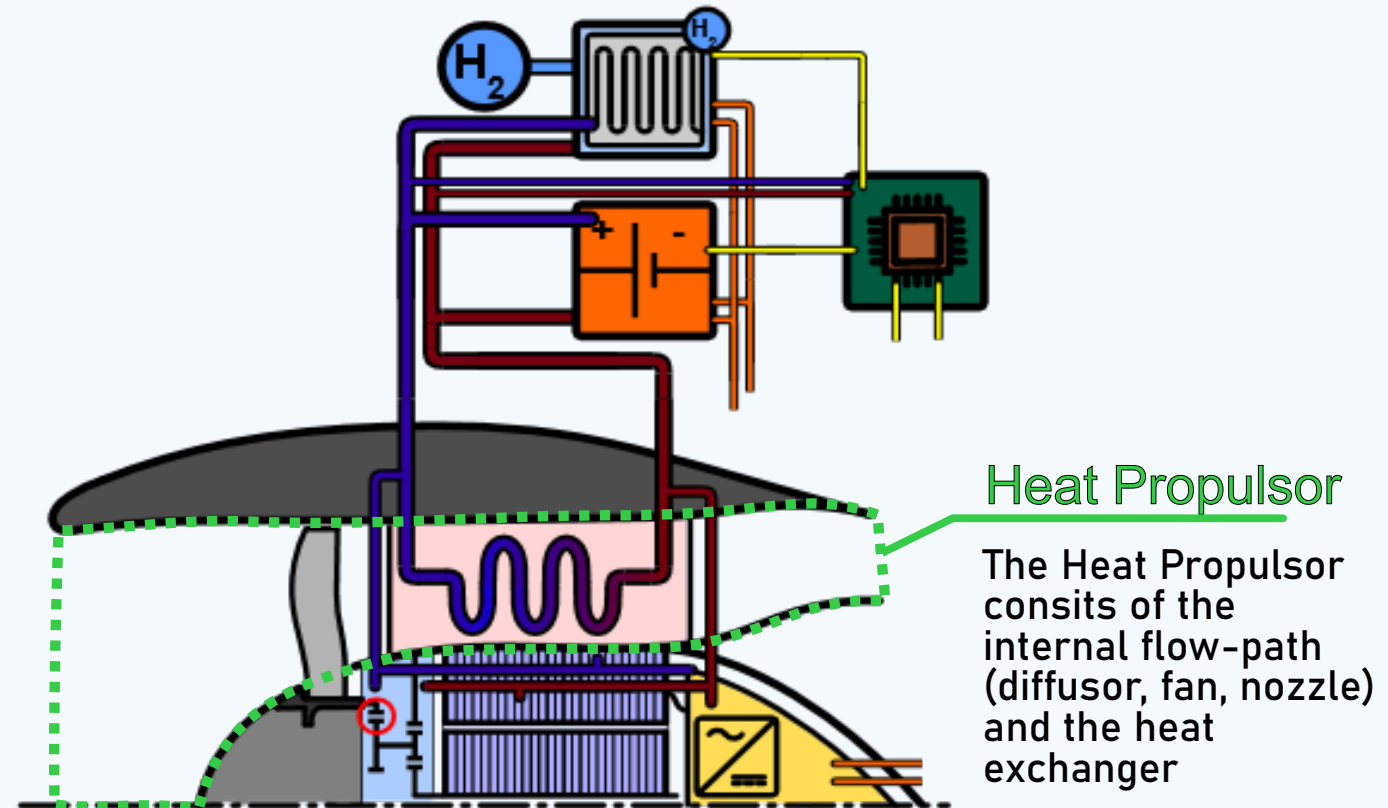

# Parameter Study - Assumptions

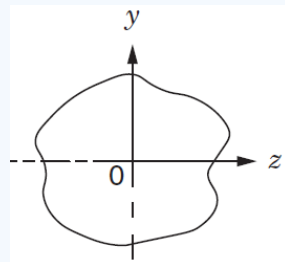
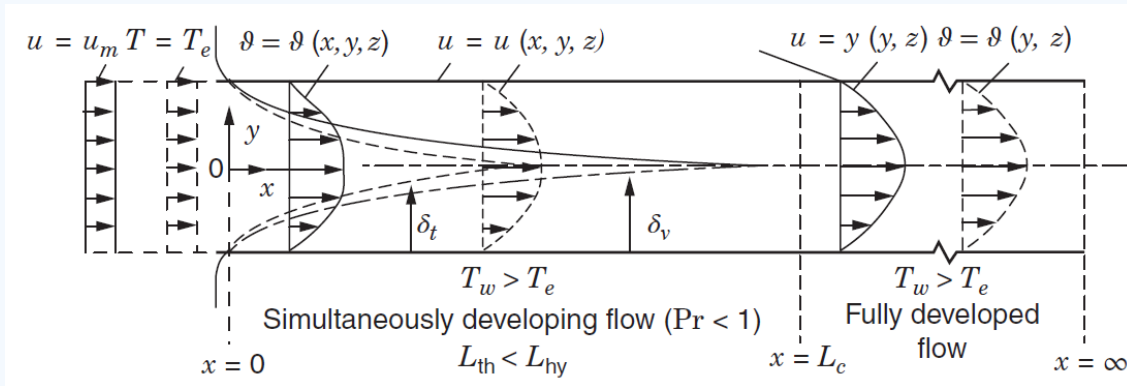

Present  
parameter  
study

plate (aka tubes => liquid  
coolant channels)

pins form air flow path

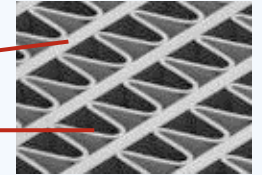

## HX air side settings

- Friction losses in the HX
- 1D-Modelling (based on hydraulic diameter)
- Counter flow compact plate and fin HX (real HX may be of crossflow type)
- Two fluid, direct transfer, single pass
- Blockage due to coolant plate/tubes is neglected
- Fully developed turbulent flow, Prandtl number  $Pr = 0.72$

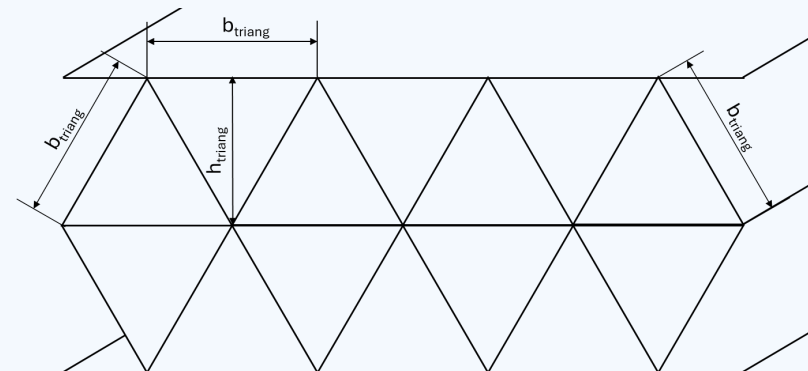

$$b_{\text{triang}} = 10 \text{ mm}$$

Source: Sekulic D.P., Shah R.K.: Fundamentals of heat exchanger design, Wiley, 2003

# Parameter Study - Results



- Transfer efficiency
  - contains fan and HX losses and
  - ram jet effect
- Best ram jet performance at high fan pressure ratios (FPR's)
- Above 11km
  - $T_{amb} = \text{const.}$ ; pressure further decreases
  - no further reduction in HX size due to decreasing temperature difference (HX coolant entry and ambient)

ISA temperature deviation (K)	0.0
Freestream Mach number	0.78
Fan inlet Mach number	0.5
Fan polytropic efficiency	0.85
Fuel cell and electric drive combined efficiency	0.5
Ratio of HX air inlet to fan inlet areas	3.0
Hot side inflow temperature (°C)	80
Net thrust (kN)	23.020

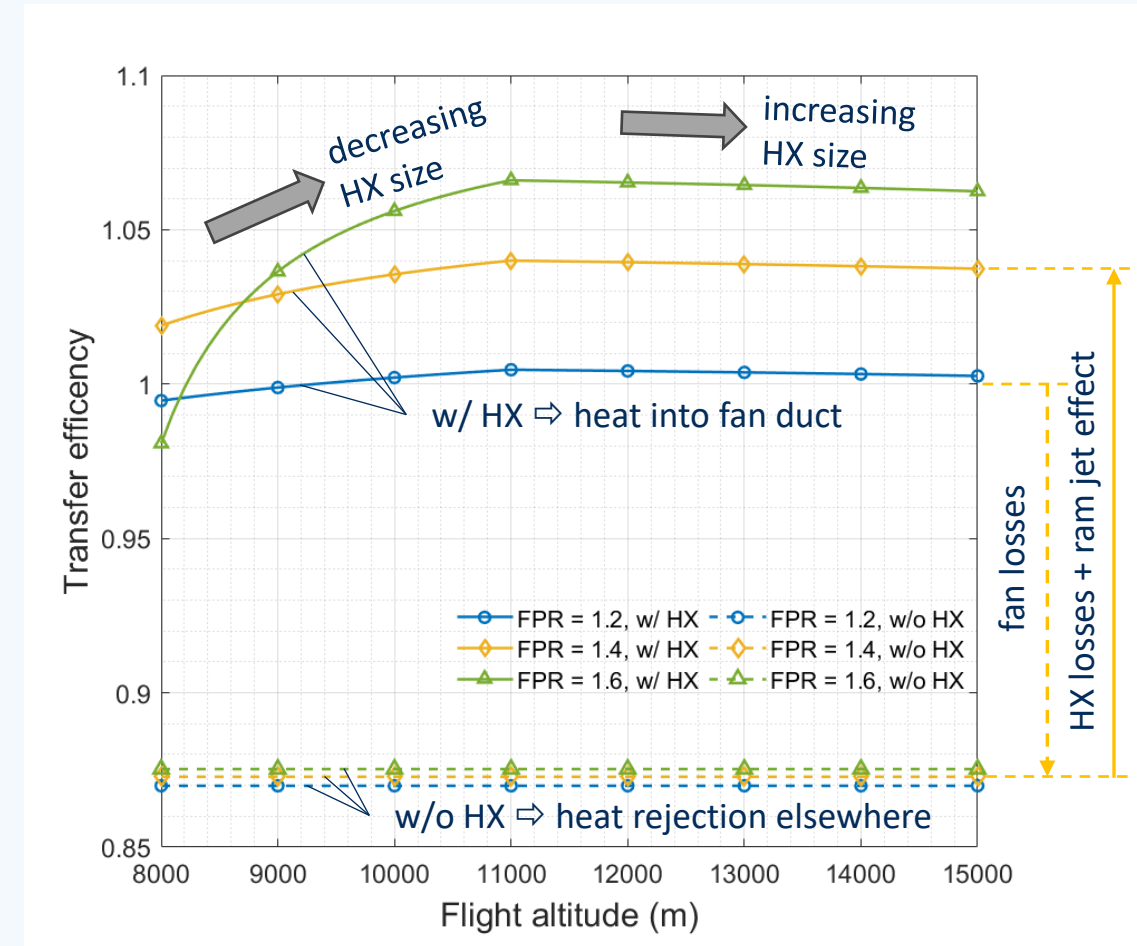

$$\eta_{trans} = \frac{P_{kin,j}}{P_{br}} = \frac{\text{Kinetic jet power}}{\text{Power at fan shaft}} \quad 9$$



# Parameter Study - Results



- Higher jet velocities with increased FPR's  
 ⇒ Jet propulsive efficiency decreases
- Ram jet effect further adds to jet velocities and jet kinetic power  $P_j$   
 ⇒ Jet propulsive efficiency w/ HX is always lower than w/o HX for a fixed FPR

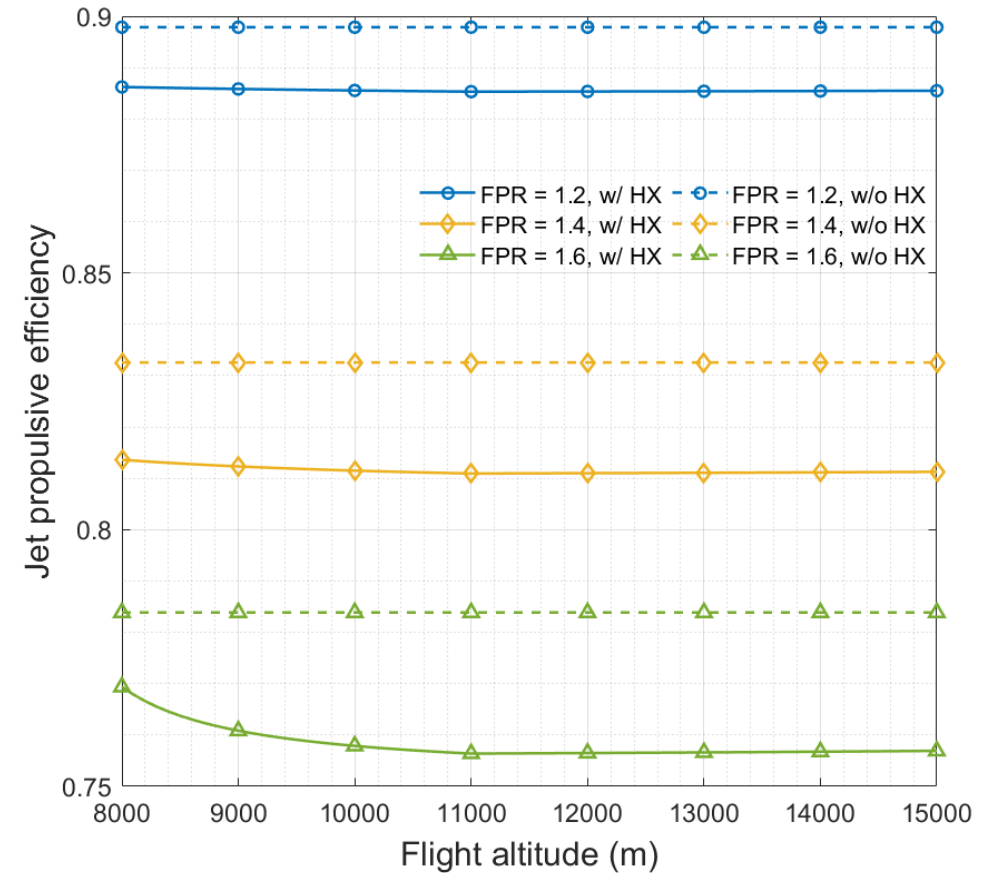
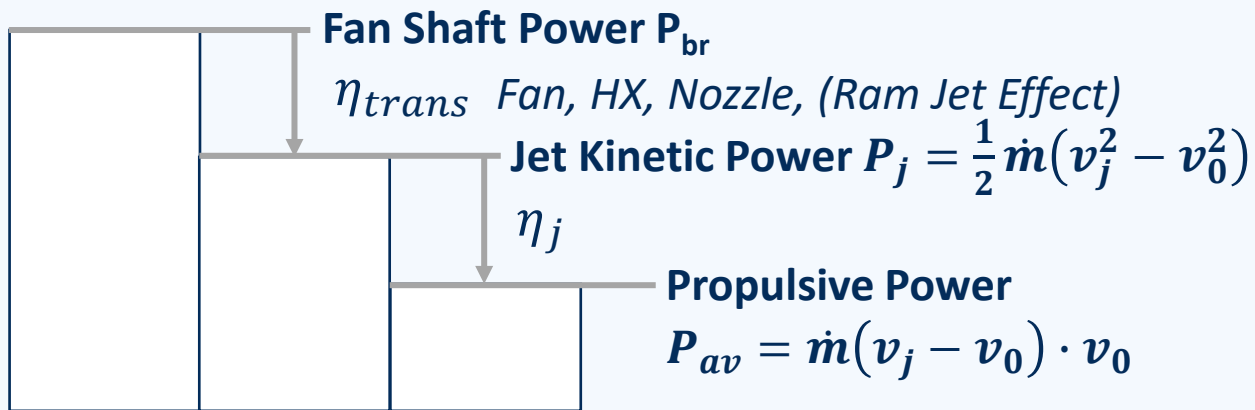

$$\eta_j = \frac{P_{av}}{P_j} = \frac{\text{Propulsive power}}{\text{Jet kinetic power}}$$

# Parameter Study - Results



## Efficiency gains

- Diagram example:
  - FPR = 1.2
  - H = 11 km
- Ram jet potential considering losses in terms of total efficiency:
  - Net gain: + 5.4%
  - + 13.9% w. r. t. “w/o HX” case

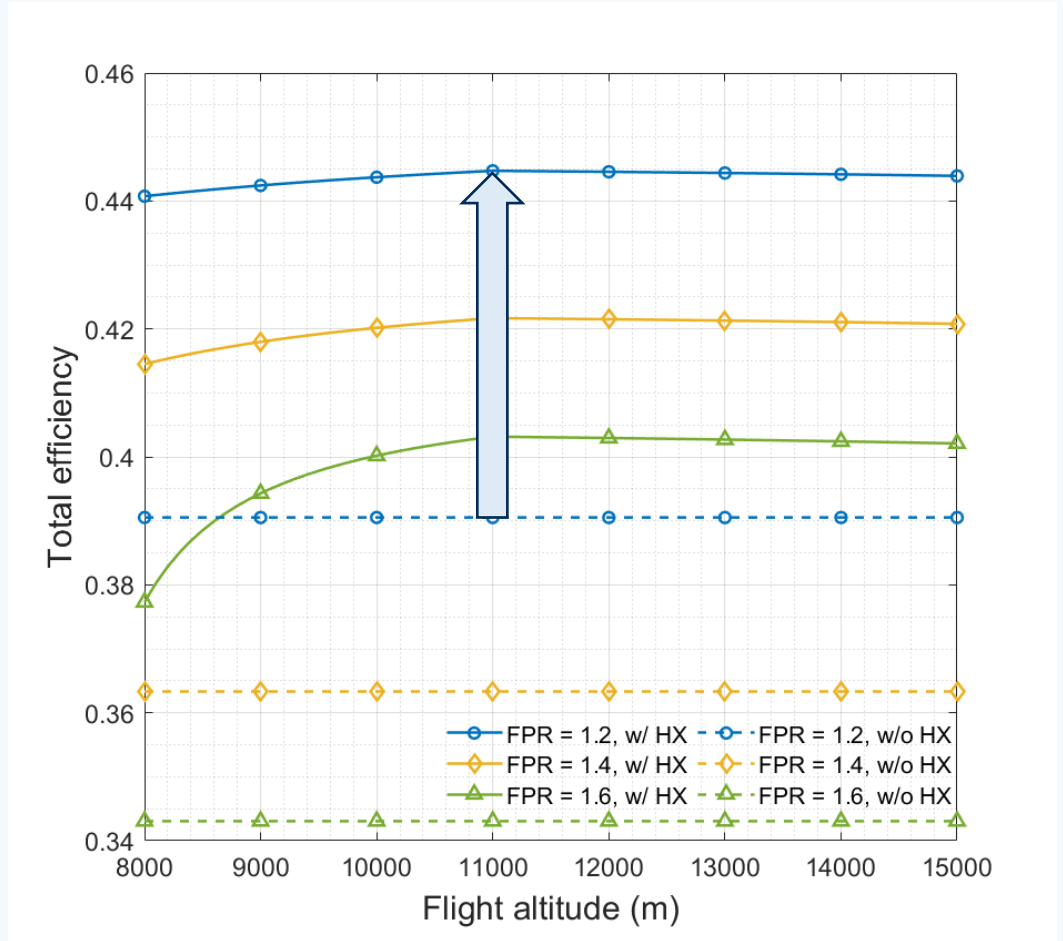

$$\eta_{tot} = \frac{P_{av}}{P_{Fuel}} = \frac{\text{Propulsive power}}{\text{Fuel power}}$$

# Parameter Study - Results

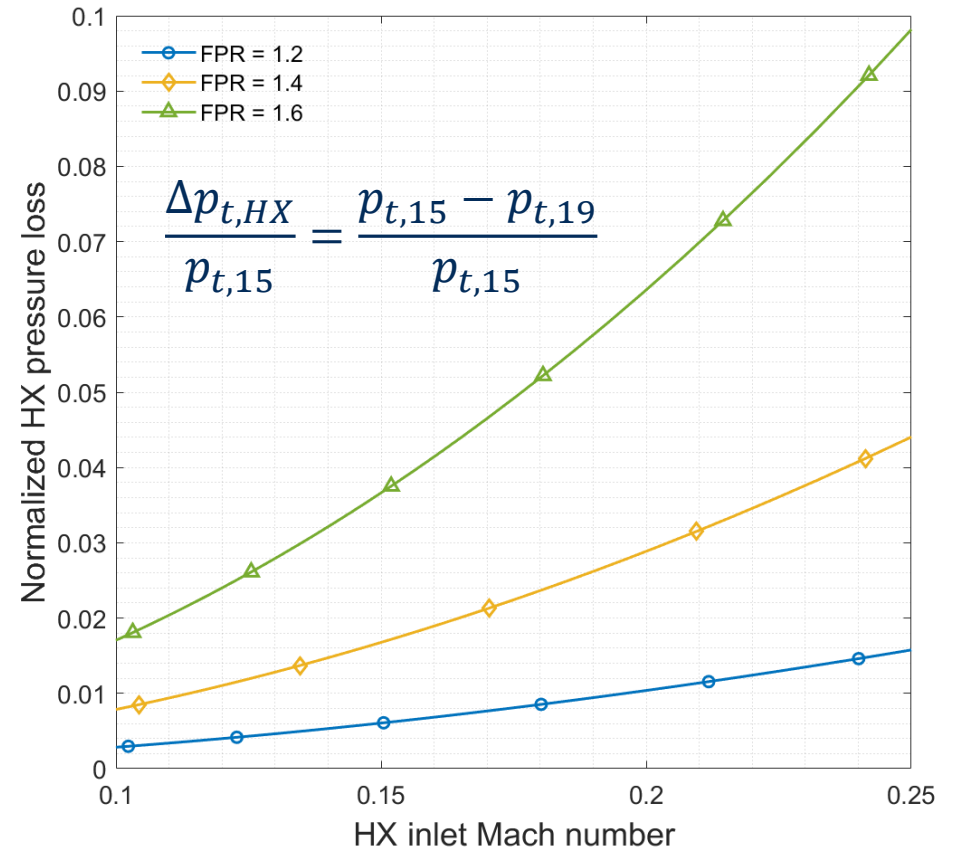
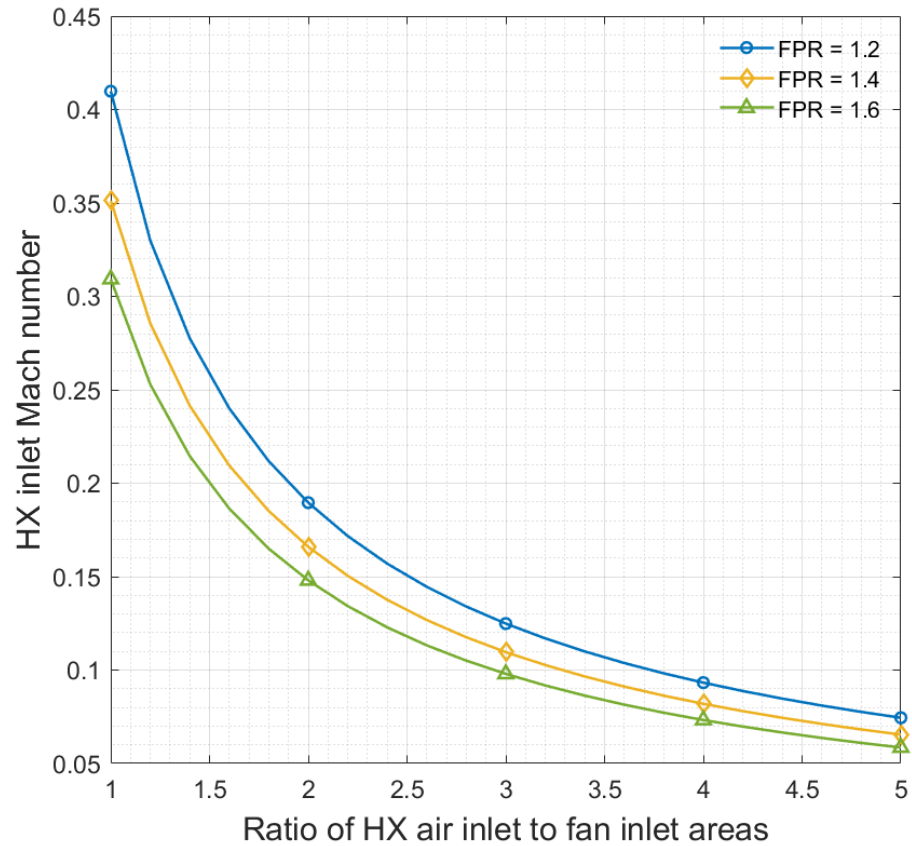

# Parameter Study - Results

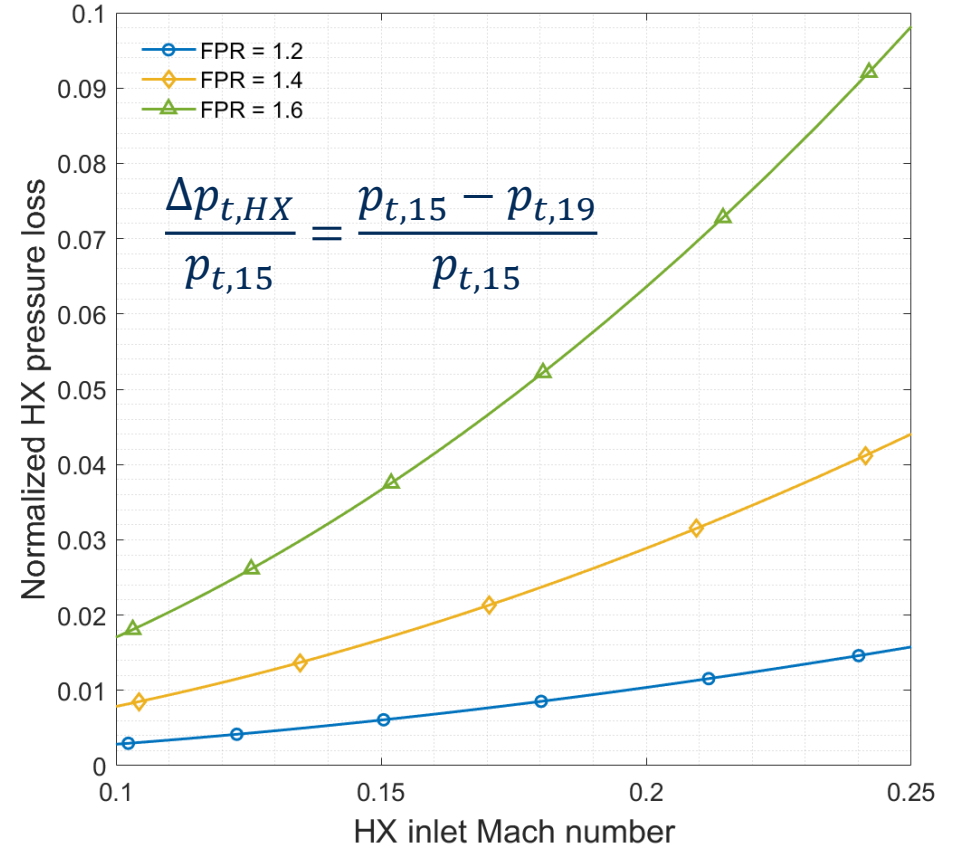
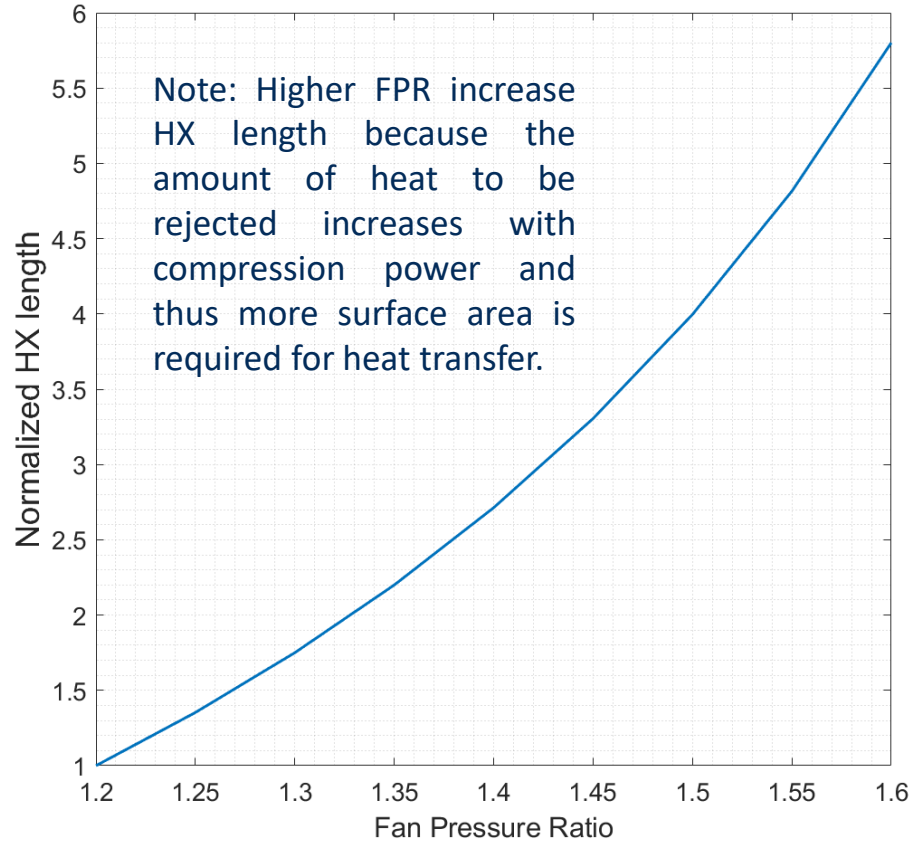

# Parameter Study - Results



- HX losses decrease with hot side inflow temperature because of reduced HX size  $\Rightarrow$  Efficiency increases

	Take Off	Cruise
Flight altitude in ft	0.0	35000
ISA temperature deviation in K	0.0	
Freestream Mach number	0.22	0.78
Fan polytropic efficiency	0.85	
Fuel cell and electric drive combined efficiency	0.5	
Fan total pressure ratio (FPR)	1.2 – 1.6	
Net thrust in kN	120.143	23.020
Fan Inlet Mach number	0.5	
Ratio of HX air inlet to fan inlet areas	3.0	

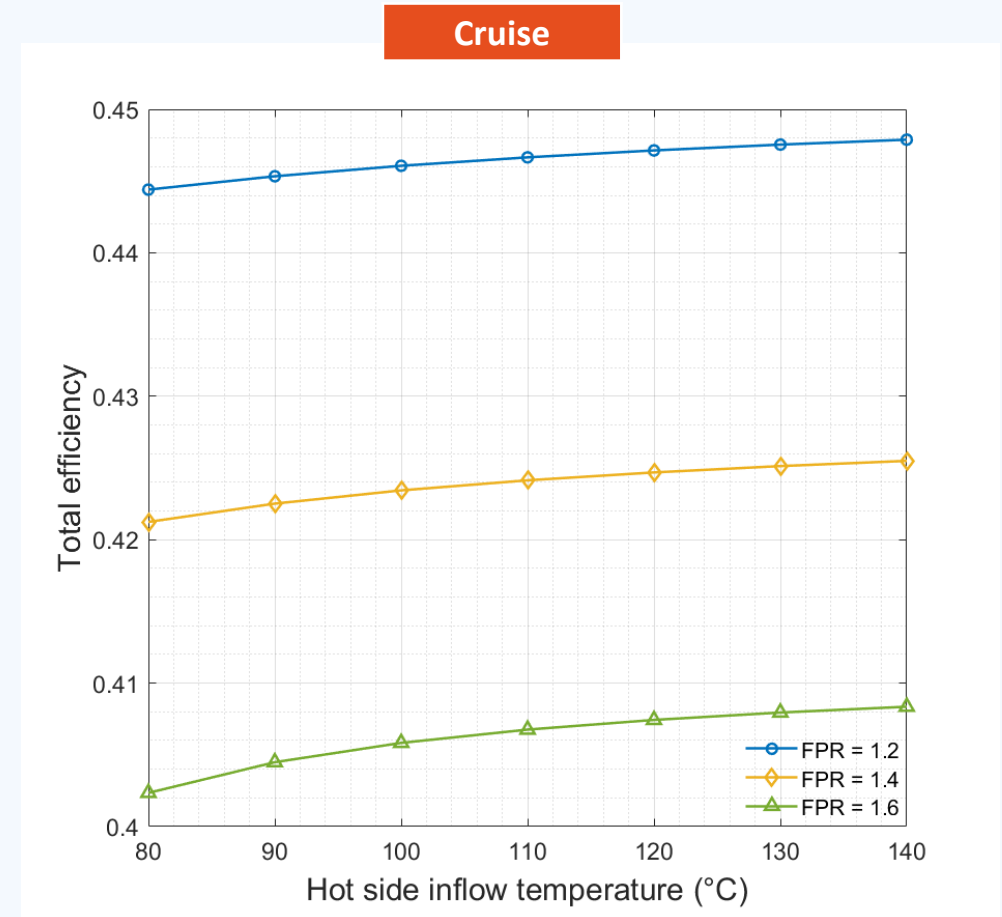

$$\eta_{tot} = \frac{P_{av}}{P_{Fuel}} = \frac{\text{Propulsive power}}{\text{Fuel power}}$$

# Parameter Study - Results



Take Off

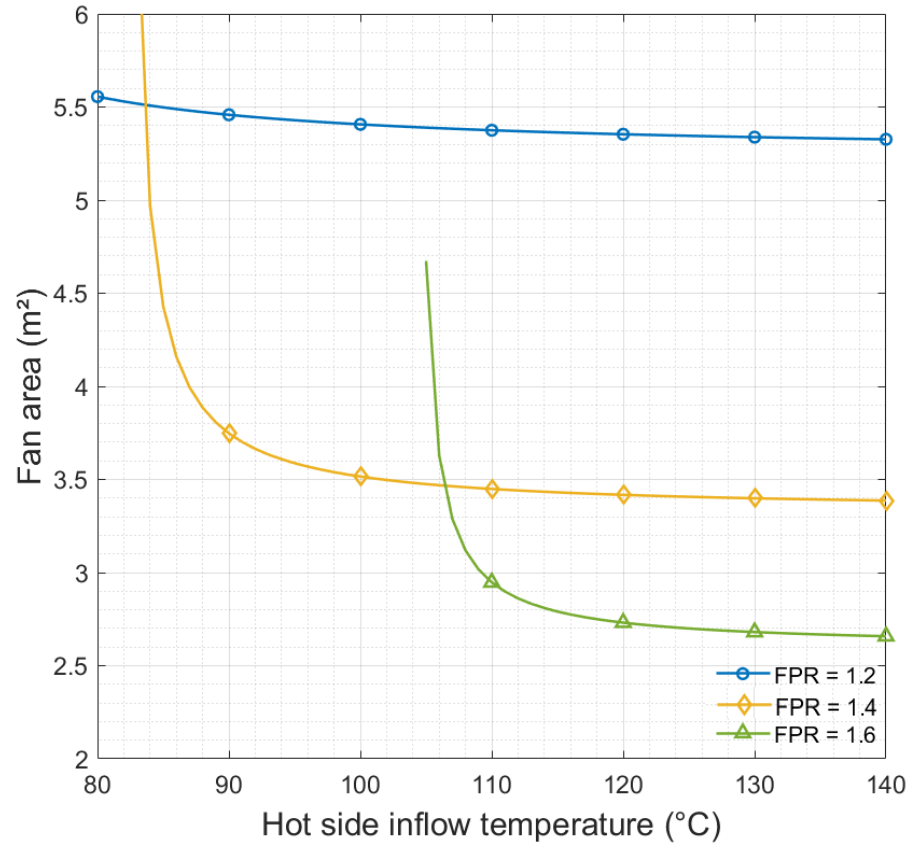

Cruise

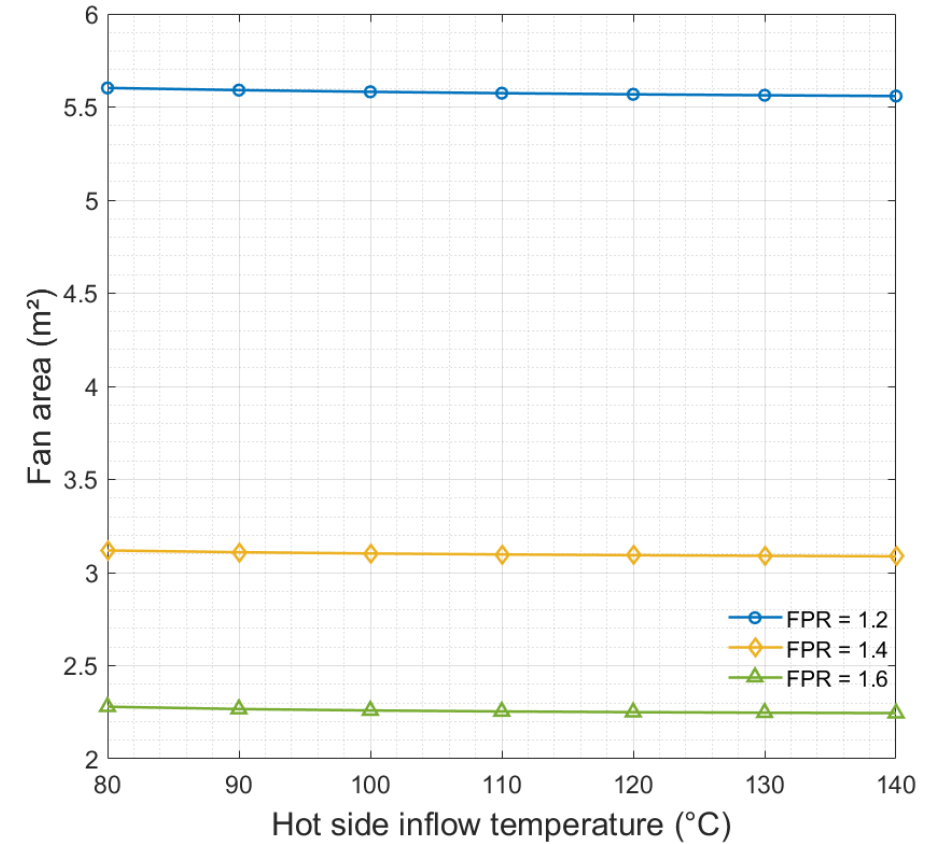

# Parameter Study - Results



### Take Off

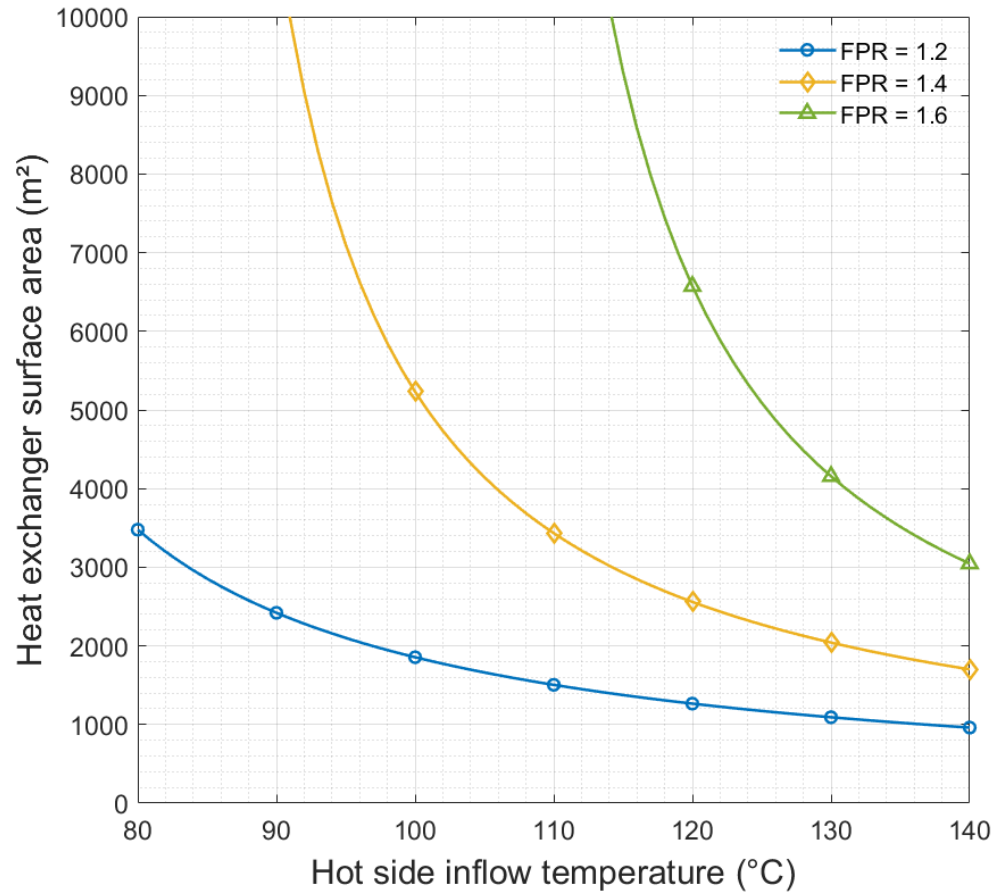

### Cruise

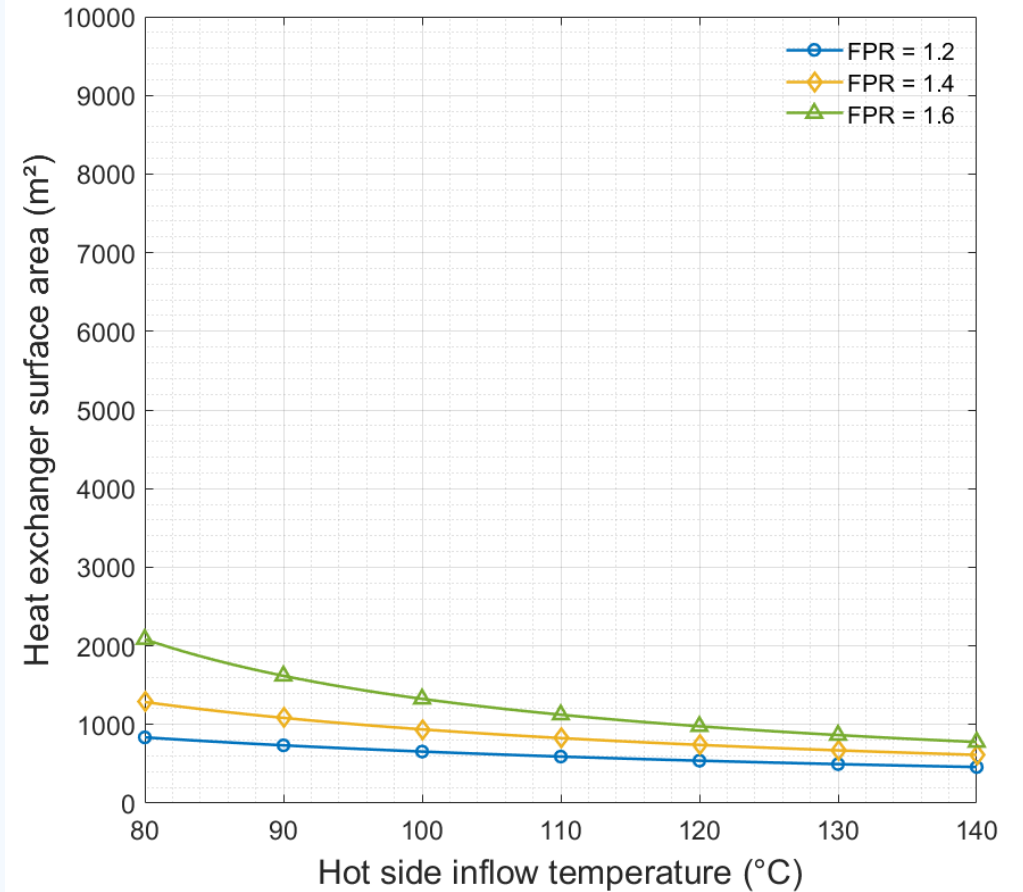

# Conclusions and Outlook



## Conclusions

- Ram jet effect increases with flight Mach number
- Heat exchanger size depends
  - on coolant temperature (“heat quality”) and
  - installed system power / heat load
- Thermodynamic sweet spot
  - Heat in fan flow and ram jet effect reward increased FNPR’s (and hence FPR’s for fixed  $M_0$ )
  - This partially offsets the trend towards lower FNPR’s for increased propulsive efficiency
  - Tropopause altitude
- Net benefits by ram jet effect even when pressure losses taken into account
- Nacelle integration is principally possible!

This is an “artists impression” of a nacelle type integration

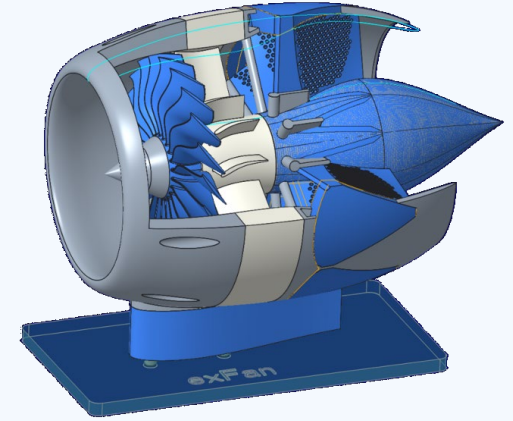

## Outlook

- Enhanced models include
  - Advanced compact HX features (offset strip fin, louvers, bionic designs)
  - Fuel cell system ancillaries power variation
  - Nacelle external drag and system masses
  - Aircraft performance (fuel mileage, costs, LCA)
  - Propulsion system airframe integration and snowball effects
- Challenges:
  - Match sea level take off and cruise req.’s
  - Hot day take off



Funded by  
the European Union



# Conclusions and Outlook



## Take Off

## Cruise

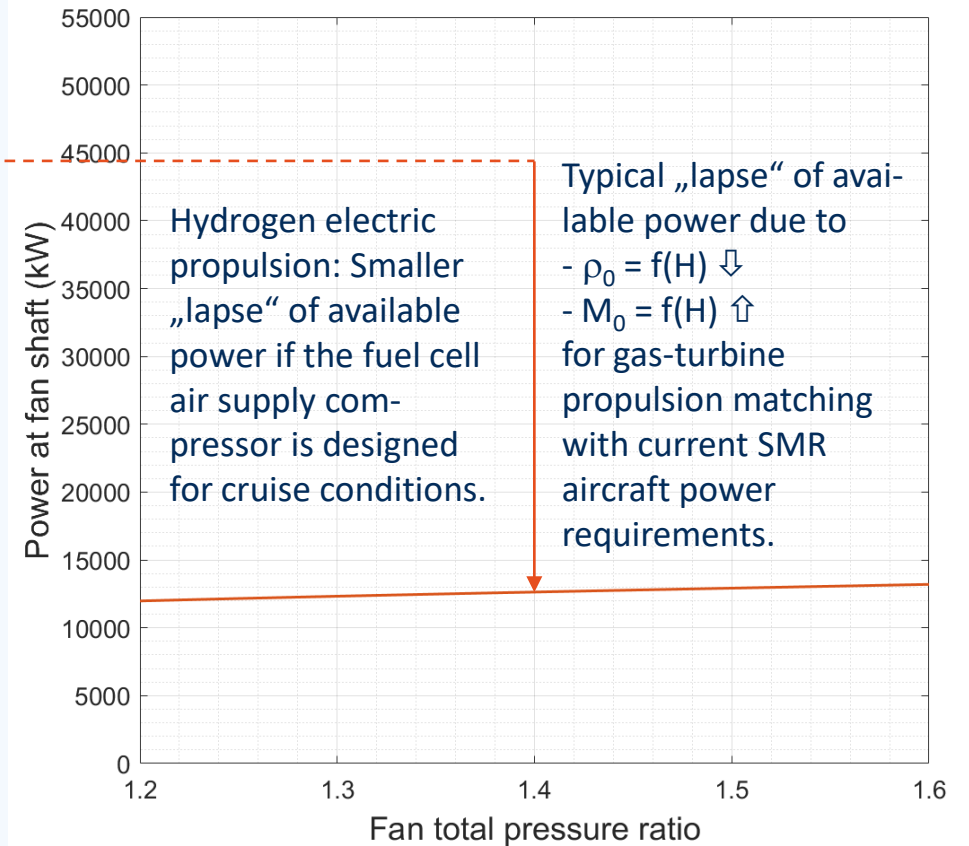
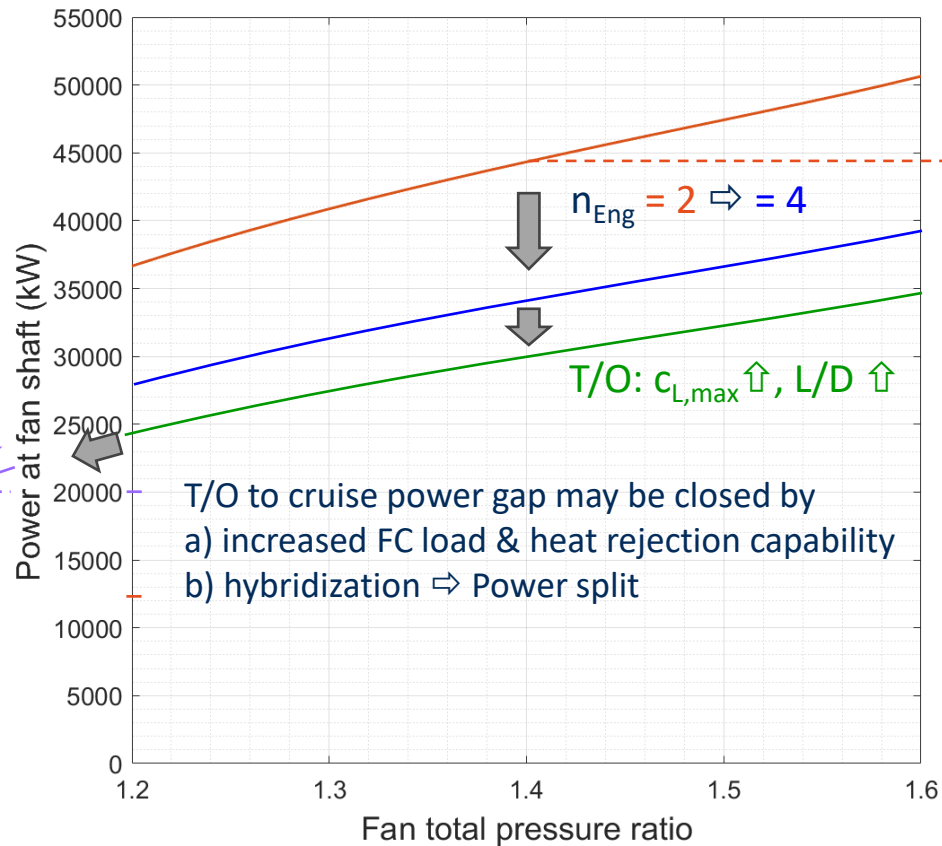



# EXFAN

„The challenges of the industry are huge, but so are the opportunities.“

Univ.-Prof. Dipl.-Ing. Dr.-Ing. **Martin Berens**, MSc  
BMK Endowed Professorship  
TU Vienna, Institute of Engineering Design and Product Development E307  
Lehárgasse 6 / BD 03 B33 / 1060 Vienna / Austria  
T: +43 1 58801 **30772**  
M: +43 664 60588 2105  
[martin.berens@tuwien.ac.at](mailto:martin.berens@tuwien.ac.at)



Funded by  
the European Union

Funded by the European Union. Views and opinions expressed are however those of the author(s) only and not necessarily reflect those of the European Union or CINEA. Neither the European Union nor CINEA can be held responsible for them.

# The EXFAN team



## Project Coordinator



## Technical Coordinator

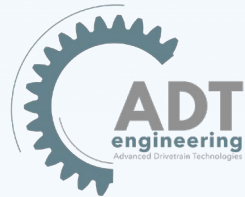

## Research Coordinator



## Project Partners

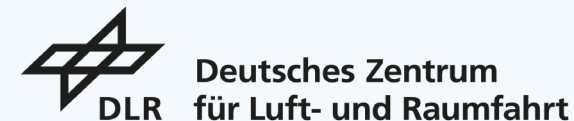

# Acknowledgements



Funded by  
the European Union

Funded by the European Union. Views and opinions expressed are however those of the author(s) only and not necessarily reflect those of the European Union or CINEA. Neither the European Union nor CINEA can be held responsible for them.

This document and its contents remain the property of the beneficiaries of the **exFan consortium**. It may contain information subject to intellectual property rights. No intellectual property rights are granted by the delivery of this document or the disclosure of its content. Reproduction or circulation of this document to any third party is prohibited without the consent of the author(s).